

Hoval UltraGas® (15-100)

Gas condensing boiler

- Steel boiler with condensation technology
- For the combustion of:
 - natural gas E
 - natural gas E with a hydrogen content (H₂) of up to 20 %
 - propane according to DIN 51622
 - biomethane according to EN 16723
- Combustion chamber made of stainless steel
- Maximal flue gas condensation through downstream heating surface made of **aluFer®** stainless steel bounded pipe; heating gas side: aluminium water side: stainless steel
- Thermal insulation with mineral wool mat
- Water pressure sensor (minimum and maximum pressure limiter integrated)
- Flue gas temperature sensor with flue gas limiter function
- Pre-mix burner
 - with blower and venturi
 - modulating operation
 - automatic ignition
 - ionisation guard
 - gas pressure monitor
- Gas boiler fully cased with steel plate, red powder-coated
- Heating connections to left and right for:
 - flow
 - return - high temperature
 - return - low temperature
- **UltraGas® (15-50):**
Flue gas connection backwards to the top
- **UltraGas® (70,100):**
concentrical supply air/flue gas connection, vertically upwards, horizontally to rear as option, see accessories and dimension sheet
- TopTronic® E controller installed
- Possibility of connecting an external gas solenoid valve with error output

TopTronic® E controller

Control panel

- Colour touchscreen 4.3 inch
- Heat generator blocking switch for interrupting operation
- Fault signalling lamp

TopTronic® E control module

- Simple, intuitive operating concept
- Display of the most important operating statuses
- Configurable start screen
- Operating mode selection
- Configurable day and week programmes
- Operation of all connected Hoval CAN bus modules
- Commissioning wizard
- Service and maintenance function
- Fault message management
- Analysis function
- Weather display (with online HovalConnect)
- Adaptation of the heating strategy based on the weather forecast (with online HovalConnect)



Model range

UltraGas® type		Nominal heat output 50/30 °C kW
(15)	A	3.0-15.2
(20)	A	4.0-20.2
(27)	A	5.0-26.9
(35)	A	5.8-34.3
(50)	A	8.0-48.8
(70)	A	13.5-69.0
(100)	A	20.9-99.0

Energy efficiency class of the compound system with control.

TopTronic® E basic module heat generator TTE-WEZ

- Control functions integrated for
 - 1 heating/cooling circuit with mixer
 - 1 heating/cooling circuit without mixer
 - 1 hot water charging circuit
 - bivalent and cascade management
- Outdoor sensor
- Immersion sensor (calorifier sensor)
- Contact sensor (flow temperature sensor)
- RAST 5 basic plug set

Options for TopTronic® E controller

- Can be expanded by max. 1 module expansion:
 - module expansion heating circuit or
 - module expansion heat balancing or
 - module expansion Universal
- Can be networked with a total of up to 16 controller modules:
 - heating circuit/hot water module
 - solar module
 - buffer module
 - measuring module

Number of modules that can be additionally installed in the heat generator:

- 1 module expansion and 1 controller module **or**
- 2 controller modules

The supplementary plug set must be ordered in order to use expanded controller functions.

Further information about the TopTronic® E see "Controls"

Optional

- For propane
- Free-standing calorifier see Calorifiers
- Flue gas systems

Delivery

- Floor-standing gas condensing boiler fully cased

Floor-standing gas condensing boiler

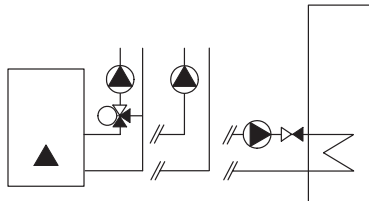

Hoval UltraGas® (15-100)

Floor-standing gas condensing boiler with built-in Hoval TopTronic® E control

- Control functions integrated for
- 1 heating circuit with mixer
 - 1 heating circuit without mixer
 - 1 hot water charging circuit
 - bivalent and cascade management
- Can be optionally expanded by max. 1 module expansion:
 - module expansion heating circuit or
 - module expansion heat balancing or
 - module expansion Universal
 - Can be optionally networked with a total of up to 16 controller modules (incl. solar module)

Boiler made of steel with TopTronic® E control, combustion chamber made of stainless steel. Secondary heating surfaces made of **aluFer®** stainless steel composite pipe. Premix burner with blower. Modulating burner.

Boiler permissions

UltraGas® (15-100)

CE product ID No. CE-0085AQ0620

Delivery
Gas boiler fully panelled

UltraGas® type		Nominal heat output 50/30 °C kW	Part No.
(15)	A ➤	3.0-15.2	7013 300
(20)	A ➤	4.0-20.2	7013 301
(27)	A ➤	5.0-26.9	7013 302
(35)	A ➤	5.8-34.3	7013 303
(50)	A ➤	8.0-48.8	7013 304
(70)	A ➤	13.5-69.0	7011 990
(100)		20.9-99.0	7011 991

Energy efficiency class of the compound system with control

Accessories

Part No.

Modification set for propane
for UltraGas® (15-70)

6047 605

Modification set for propane
for UltraGas® (100)

6047 609

Necessary accessories for
room air independent operation



Connection set for room air independent operation without sound absorber
for UltraOi® (16-35), UltraGas® (15-50)
Consisting of:
corrugated pipe Ø 50 mm for combustion air supply to burner.
Concentric boiler connection piece E80 -> C80/125 PP for flue gas and supply air.
Necessary if no Hoval LAS flue gas line system is used.

6027 510

In the UltraGas®, ventilation of the installation or boiler room must be guaranteed for operation INdependent from the room air.

For room air independent operation with separate combustion air duct (not concentrical).

Accessories

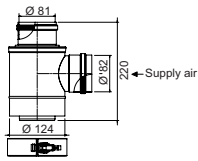

Separating piece C80/125 -> 2 x E80 PP
for room air independent operation
for separate conduction of flue gas and
combustion air.

2010 174

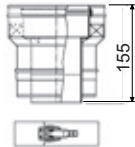

Adapter piece C80/125 -> C100/150 PP

2018 533

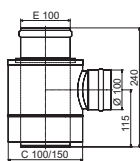

Separating piece C100/150 -> 2 x E100 PP
for UltraOil® (35,50),
TopGas® classic (35-80),
UltraGas® (50-100)
for separate conduction of flue gas and
combustion air (LAS-system)
Recommendation:

2015 244

If the air inlet at the facade is near a
noise sensitive place (window of bedroom,
terrace etc.), we recommend
to use a sound absorber at the
direct combustion air inlet.



Horizontal flue gas connection E100 PP
for UltraOil® (50), UltraGas® (70,100)
for the conversion of the vertical
flue gas connection (series delivery)
to a horizontal to rear routed
flue gas connection.

6016 933



Suction tube for combustion air
for UltraGas® (70)
only necessary with horizontal and
concentric flue gas connection
(separate ducting of combustion air
and flue gas).
Connection "Horizontal flue gas
connection E100 PP" essential,
ø 75 mm
The boiler room must be ventilated.

6017 288

TopTronic® E module expansions
for TopTronic® E basic module heat generator

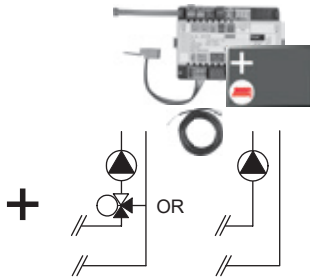

Notice
The supplementary plug set may have to be ordered to implement functions differing from the standard!

TopTronic® E module expansion heating circuit TTE-FE HK
Expansion to the inputs and outputs of the basic module heat generator or the heating circuit/domestic hot water module for implementing the following functions:
- 1 heating/cooling circuit w/o mixer or
- 1 heating/cooling circuit with mixer
Consisting of:
- Fitting accessories
- 1 contact sensor
ALF/2P/4/T, L = 4.0 m
- Basic plug set FE module

6034 576

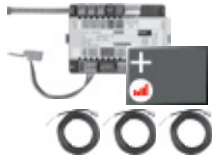

Notice
The flow rate sensor set must be ordered as well.

TopTronic® E module expansion heating circuit incl. energy balancing TTE-FE HK-EBZ
Expansion to the inputs and outputs of the basic module heat generator or the heating circuit/domestic hot water module for implementing the following functions:
- 1 heating/cooling circuit w/o mixer or
- 1 heating/cooling circuit with mixer incl. energy balancing in each case
Consisting of:
- Fitting accessories
- 3 contact sensors
ALF/2P/4/T, L = 4.0 m
- Plug set FE module

6037 062

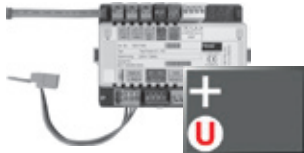

Notice
Refer to the Hoval System Technology to find which functions and hydraulic arrangements can be implemented.

TopTronic® E module expansion Universal TTE-FE UNI
Expansion to the inputs and outputs of a controller module (basic module heat generator, heating circuit/domestic hot water module, solar module, buffer module) for implementing various functions
Consisting of:
- Fitting accessories
- Plug set FE module

6034 575

Further information
see "Controls" - "Hoval TopTronic® E module expansions" chapter



Flow rate sensor sets
Plastic housing

Size	Connection inches	Flow rate l/min
DN 8	G 3/4"	0.9-15
DN 10	G 3/4"	1.8-32
DN 15	G 1"	3.5-50
DN 20	G 1 1/4"	5-85
DN 25	G 1 1/2"	9-150

6038 526
6038 507
6038 508
6038 509
6038 510



Flow rate sensor sets
Brass housing

Size	Connection inches	Flow rate l/min
DN 10	G 1"	2-40
DN 32	G 1 1/2"	14-240

6042 949
6042 950

Accessories for TopTronic® E



TopTronic® E controller modules

TTE-HK/WW	TopTronic® E heating circuit/ hot water module	6034 571
TTE-SOL	TopTronic® E solar module	6037 058
TTE-PS	TopTronic® E buffer module	6037 057
TTE-MWA	TopTronic® E measuring module	6034 574

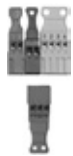

Supplementary plug set

	for basic module heat generator TTE-WEZ	6034 499
	for controller modules and module expansion	6034 503
	TTE-FE HK	



TopTronic® E room control modules

TTE-RBM	TopTronic® E room control modules	
	easy white	6037 071
	comfort white	6037 069
	comfort black	6037 070



Enhanced language package TopTronic® E

	one SD card required per control module	6039 253
	Consisting of the following languages:	
	HU, CS, SL, RO, PL, TR, ES, HR,	
	SR, JA, DA	



HovalConnect

	HovalConnect LAN	6049 496
	HovalConnect WLAN	6049 498
	HovalConnect Modbus	6049 501
	HovalConnect KNX	6049 593

TopTronic® E interface modules

	GLT module 0-10 V	6034 578
--	-------------------	----------



TopTronic® E sensors

AF/2P/K	Outdoor sensor	2055 889
	H x W x D = 80 x 50 x 28 mm	
TF/2P/5/6T	Immersion sensor, L = 5.0 m	2055 888
ALF/2P/4/T	Contact sensor, L = 4.0 m	2056 775
TF/1.1P/2.5S/6T	Collector sensor, L = 2.5 m	2056 776



Bivalent switch

	for various release or switching functions	
	Bivalent switch 1-piece	2056 858
	Bivalent switch 2-piece	2061 826

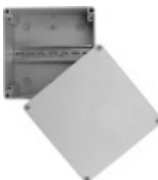

System housing

	System housing 182 mm	6038 551
	System housing 254 mm	6038 552



TopTronic® E wall casing

WG-190	Wall casing small	6052 983
WG-360	Wall casing medium	6052 984
WG-360 BM	Wall casing medium with control module cut-out	6052 985
WG-510	Wall casing large	6052 986
WG-510 BM	Wall casing large with control module cut-out	6052 987

Further information
see "Controls"

Accessories

Part No.

Flow temperature guard

for under floor heating (1 guard per heating circuit) 15-95 °C, switching difference 6 K, capillary tube max. 700 mm, setting (visible from the outside) inside the housing cover.



Clamp-on thermostat *RAK-TW1000.S*
Thermostat with strap,
enclosed cable and plug

242 902



Set clamp-on thermostat *RAK-TW1000.S*
Thermostat with strap,
with cable (4 m) and plug

6033 745



Immersion thermostat *RAK-TW1000.S SB 150*
Thermostat with immersion sleeve ½"
- depth of immersion 150 mm, brass nickel-plated

6010 082

CO monitor

For safety shut-off of the boiler on leakage of carbon monoxide incl. connection cable

6043 277



Installation example

for UltraGas® (15-50)

Safety set SG15-1"

Suitable up to max. 50 kW
complete with safety valve (3 bar)
Pressure gauge and autom.
aspirator with shut-off valve.
Connection: DN 15, 1" internal thread

641 184



Installation example

for UltraGas® (70, 100)

Safety set SG20-1"

Area of application up to 100 kW
complete with safety valve (3 bar)
Pressure gauge and autom.
aspirator with shut-off valve.
Connection: DN 20-1" internal thread

6014 390



Boiler socket

for MultiJet® (20,25),
UltraOil® (16-35), UltraGas® (15-50)
to elevate the condensate drainage
made of steel
height 150 mm
anthracite painted

6025 418

Accessories



Gas valve
with thermally releasing cut-off device.

Type	Connection inches
DN 15	R ½"
DN 20	R ¾"
DN 25	R 1"



Gas filter
with measurement nozzle before and behind the filter inset (diameter: 9 mm)
Pore width of the filter inset < 50 µm
Max. pressure difference 10 mbar
Max. inlet pressure 100 mbar

Type	Connection inches
70612/6B	Rp ¾"
70602/6B	Rp 1"

Part No.

2012 075
2012 077
2069 324

2007 995
2007 996

**Condensate drain for
Hoval UltraGas® (15-90)**



Condensate pump
for transporting condensate
into a higher drainage duct
Including connection lines
Completely wired, cable and plug
For connection to the boiler controller
Delivery head: max. 4 m
Can be combined with neutralisation box

Part No.

6045 476

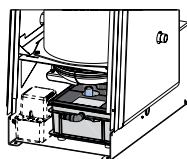

Neutralisation box
for transporting condensation water into
a lower lying drainage duct
incl. condensate neutralisation
incl. neutralisation granulate 3 kg
combinable with condensate pump
can be mounted in boiler socket

6024 764



Neutralisation granulate
for neutralisation box
Refill set volume 3 kg
Life time of one filling:
approx. 1 year, depending on amount
of condensate

2028 906

**Condensate drain for
Hoval UltraGas® (70,100)**

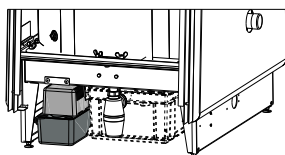

Condensate pump
for UltraOil® (50), UltraGas® (70,100)
for transporting condensate
into a higher drainage duct
Including connection lines
Completely wired, cable and plug
For connection to the boiler controller
Delivery head: max. 4 m
Can be combined with neutralisation box
can be mounted in boiler socket

6061 127

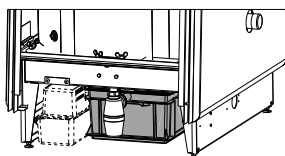

Neutralisation box
for UltraOil® (50), UltraGas® (70,100)
for transporting condensation water into
a lower lying drainage duct incl.
neutralisation granulate 6 kg.
Combinable with condensate pump;
can be mounted in boiler socket

6012 553



Neutralisation granulate
for neutralisation box
Refill set volume 3 kg
Life time of one filling:
approx. 1 year, depending on amount
of condensate

2028 906

Boiler connection set



Connection set AS 25-S/NT/HT
 for mounting a heating regulating armature HA25 for MultiJet® (12,16), UltraOil® (16,20), UltraGas® (15,27)
 Rigid flow pipe and flexible return pipe
 Suitable for left or right connection
 Low/high temperature
 Connection set completely insulated
 For mounting a heating regulating armature HA20 an adapter set DN 20-DN 25 is required.

6017 055



Connection set AS 32-S/NT/HT
 for mounting a heating regulating armature HA32 for UltraGas® (35,50)
 Rigid flow pipe and flexible return pipe with fastening material
 Suitable for left or right connection
 Low/high temperature
 Connection set completely insulated
 For mounting a heating regulating armature HA25 an adapter set DN 25-DN 32 is required.

6014 846



Connection set AS 40-S/NT/HT
 for mounting a heating regulating armature HA40 for UltraOil® (50), UltraGas® (70,100)
 Rigid flow pipe and flexible return pipe with screw flange R 1½"
 Suitable for left or right connection
 Low/high temperature
 Connection set completely insulated
 For mounting a heating regulating armature HA32 an adapter set DN 32-DN 40 is required.

6014 848



Connection set AS 25-LG
 for mounting a Compact charging group LG-2 for MultiJet® (12,16), UltraOil® (16-35), UltraGas® (15-27)
 Suitable for left or right connection
 Low-temperature return
 Connection set completely insulated
 made of flexible pipes

6034 818

Heating armature groups



Heating armature group HA-3BM-R

with 3-way motor mixer and heat-insulating box.
Installation right (flow left)

HA group/pump Speed control EEI



DN 20 (¾")

HA20-3BM-R/HSP 4	•		•	•	0.18	6051 715
HA20-3BM-R/HSP 6	•		•	•	0.20	6051 716
HA20-3BM-R/SPS-S 7	•	•	•	•	0.20	6049 541
HA20-3BM-R/SPS-S 8	•	•	•	•	0.20	6049 542

DN 25 (1")

HA25-3BM-R/HSP 6	•		•	•	0.20	6051 717
HA25-3BM-R/SPS-S 7	•	•	•	•	0.20	6049 545
HA25-3BM-R/SPS-S 8	•	•	•	•	0.20	6049 546
HA25-3BM-R					without pump	6046 642

Pumps for HA25-3BM-R

see "Circulating pumps".
Pump installation dimensions 1½" x 180 mm

DN 32 (1¼")

HA32-3BM-R/SPS-S 7	•	•	•	•	0.20	6049 549
HA32-3BM-R/SPS-S 8	•	•	•	•	0.20	6049 550
HA32-3BM-R/SPS-I 8	•	•	•	•	0.23	6059 328
HA32-3BM-R/SPS-I 12 PM1	•		•	•	0.23	6046 619
HA32-3BM-R					without pump	6046 643

Pumps for HA32-3BM-R

see "Circulating pumps".
Pump installation dimensions 2" x 180 mm

DN 40 (1½")

HA40-3M-R/SPS-I 8	•		•	•	0.23	6059 327
HA40-3M-R/SPS-I 12 PM1	•		•	•	0.23	6040 904
HA40-3M-R					without pump	6014 867

Pumps for HA40-3M

see "Circulating pumps".
Pump installation dimensions DN 40/PN 6 x 250 mm

Part No.

Speed control legend

	Δp-v	Variable differential pressure
	ENF	Vent function 10 min.
		PWM control signal heating
	Δp-c	Constant differential pressure
		Constant rotational Speed

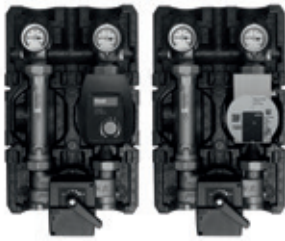

Heating armature groups



Heating armature group HA-3BM-L

with 3-way motor mixer and heat-insulating box.
Installation left (flow right)

HA group/pump Speed control EEI

 ≤

DN 20 (3/4")

HA20-3BM-L/HSP 4	•		•	•	0.18	6051 718
HA20-3BM-L/HSP 6	•		•	•	0.20	6051 719
HA20-3BM-L/SPS-S 7	•	•	•	•	0.20	6049 543
HA20-3BM-L/SPS-S 8	•	•	•	•	0.20	6049 544

DN 25 (1")

HA25-3BM-L/HSP 6	•		•	•	0.20	6051 720
HA25-3BM-L/SPS-S 7	•	•	•	•	0.20	6049 547
HA25-3BM-L/SPS-S 8	•	•	•	•	0.20	6049 548
HA25-3BM-L				without pump		6046 644

Pumps for HA25-3BM-L

see "Circulating pumps".
Pump installation dimensions 1 1/2" x 180 mm

DN 32 (1 1/4")





HA32-3BM-L/SPS-S 7	•	•	•	•	0.20	6049 551
HA32-3BM-L/SPS-S 8	•	•	•	•	0.20	6049 552
HA32-3BM-L/SPS-I 8	•	•	•	•	0.20	6059 329
HA32-3BM-L/SPS-I 12 PM1	•		•	•	0.23	6046 631
HA32-3BM-L				without pump		6046 645

Pumps for HA32-3BM-L

see "Circulating pumps".
Pump installation dimensions 2" x 180 mm

Part No.

Speed control legend





	Δp-v	Variable differential pressure
	ENF	Vent function 10 min.
		PWM control signal heating
	Δp-c	Constant differential pressure
		Constant rotational Speed



Charging group LG-2
Heating armature group HA-2

For the connection of a side calorifier or as heating circuit without mixer, with heat-insulating box. Installation right (flow left).

Charging/HA group/pump Speed control EEI





≤

DN 20 (3/4")

LG/HA20-2/HSP 4	•		•	•	0.18	6051 743
LG/HA20-2/HSP 6	•		•	•	0.20	6051 744
LG/HA20-2/SPS-S 7	•	•	•	•	0.20	6040 906
LG/HA20-2/SPS-S 8	•	•	•	•	0.20	6040 907

DN 25 (1")

LG/HA25-2/HSP 6	•		•	•	0.20	6051 745
LG/HA25-2/SPS-S 7	•	•	•	•	0.20	6049 553
LG/HA25-2/SPS-S 8	•	•	•	•	0.20	6049 554
LG/HA25-2			without pump			6046 646

Pumps for LG/HA25-2

see "Circulating pumps".
 Pump installation dimensions 1½" x 180 mm

DN 32 (1 ¼")





LG/HA32-2/SPS-S 8	•	•	•	•	0.21	6049 555
LG/HA32-2/SPS-I 8 PM1	•	•	•	•	0.20	6059 330
LG/HA32-2			without pump			6046 647

Pumps for LG/HA32-2

see "Circulating pumps".
 Pump installation dimensions 2" x 180 mm

Part No.

Speed control legend

	Δp-v	Variable differential pressure
	ENF	Vent function 10 min.
		PWM control signal heating
	Δp-c	Constant differential pressure
		Constant rotational Speed



Wall brackets

for mounting a Hoval armature group on the wall.

Type	Axle spacing	Connection		Wall clearance
	mm	top inches	bottom inches	
DN 20	90	Rp 1"	R 1"	70,85,100
DN 25	125	Rp 1½"	R 1"	87-162
DN 32	125	Rp 2"	R 1½"	142,167

Part No.

6019 209
6019 210
6025 295



Adapter set DN 20-DN 25

for the installation of the HA group DN 20 to a wall distributor DN 25 or a connection set DN 25.
Installation height: 120 mm

6013 693



Adapter set

for the installation of the HA group to a wall distributor

Type

DN 32-DN 25
DN 25-DN 32
DN 25-DN 40

6007 191
6006 954
6014 852



Adapter fitting DN 32-DN 40

for the installation of the HA group DN 32 to a wall distributor DN 40 or a connection set AS 40-S/NT/HT.

6014 863

Diaphragm pressure expansion tanks, heating armature groups and wall distributors
see "Various system components"

System modules
see "Controls"

Service



Commissioning

Commissioning by works service or Hoval trained authorised serviceman/company is condition for warranty.

For commissioning and other services please contact your Hoval sales office.

Hoval UltraGas® (15-27)

Type		(15)	(20)	(27)
• Nominal heat output at 80/60 °C, natural gas ¹⁾	kW	3.0-14.3	3.8-18.7	4.5-25.0
• Nominal heat output at 50/30 °C, natural gas ^{1), 2)}	kW	3.0-15.2	4.0-20.2	5.0-26.9
• Nominal heat output at 80/60 °C, propane ³⁾	kW	4.5-13.8	4.9-18.6	6.6-24.3
• Nominal heat output at 50/30 °C, propane ²⁾	kW	4.8-15.3	5.2-20.7	7.3-27.0
• Nominal heat input with natural gas ⁴⁾	kW	2.9-14.5	3.8-18.9	4.7-25.4
• Nominal heat input with propane ³⁾	kW	4.7-14.3	5.1-19.3	6.8-25.2
• Operating pressure heating min./max. (PMS)	bar	1/3	1/3	1/3
• Operating temperature max. (T _{max})	°C	85	85	85
• Boiler water content (V _(H2O))	l	57	55	51
• Flow resistance boiler ⁵⁾	z value	3.5	3.5	3.5
• Minimum circulation water quantity	l/h	-	-	-
• Boiler weight (without water content, incl. cladding)	kg	176	179	186
• Boiler efficiency at 80/60 °C in full-load operation (NCV/GCV)	%	97.5/87.8	97.0/88.1	97.9/88.2
• Boiler efficiency at 30 % partial load operation (NCV/GCV)	%	107.9/97.2	108.0/97.3	108.0/97.3
• Room heating energy efficiency				
- without control	ηs	%	92	92
- with control	ηs	%	94	94
- with control and room sensor	ηs	%	96	96
• NOx class (EN 15502)		-	-	-
• Nitrogen oxide emissions (EN 15502) (GCV)	NOx	mg/kWh	33	32
• CO ₂ -content in flue gas at min./max. nominal heat output	%	8.8/9.0	8.8/9.0	8.8/9.0
• Heat loss in standby mode	Watt	160	160	160
Dimensions		see table of dimensions		
• Gas flow pressure min./max.				
- Natural gas E/LL	mbar	17.4-50	17.4-50	17.4-50
- Propane	mbar	37-50	37-50	37-50
• Gas connection values at 15 °C/1013 mbar:				
- Natural gas E (Wo = 15.0 kWh/m ³) NCV = 9.97 kWh/m ³	m ³ /h	0.29-1.45	0.38-1.90	0.47-2.55
- Natural gas LL- (Wo = 12.4 kWh/m ³) NCV = 8.57 kWh/m ³	m ³ /h	0.34-1.69	0.44-2.21	0.55-2.96
- Propane (NCV = 25.9 kWh/m ³)	m ³ /h	0.18-0.55	0.20-0.75	0.26-0.97
• Operating voltage	V/Hz	230/50	230/50	230/50
• Electrical power consumption min./max.	Watt	20/44	22/62	20/56
• Stand-by	Watt	9	9	9
• Type of protection	IP	20	20	20
• Permitted ambient temperature during operation	°C	5-40	5-40	5-40
• Sound power level				
- Heating noise (EN 15036 Part 1) (room air dependent)	dB(A)	57	62	66
- Flue gas noise radiated from the mouth (DIN 45635 Part 47) (room air dependent/independent of room air)	dB(A)	43	49	55
- Sound pressure level heating noise (depending on installation conditions) ⁶⁾	dB(A)	50	56	59
• Condensate quantity (natural gas) at 40/30 °C	l/h	1.3	1.8	2.4
• pH value of the condensate	approx.	4.2	4.2	4.2
• Construction type		B23, B23P, C53, C63		
• Flue gas system				
- Temperature class		T120	T120	T120
- Flue gas mass flow at max. nominal heat input (dry)	kg/h	23	31	42
- Flue gas mass flow at min. nominal heat input (dry)	kg/h	4.7	6	7.1
- Flue gas temperature at max. nominal heat output and 80/60 °C	°C	62	63	64
- Flue gas temperature at max. nominal heat output and 50/30 °C	°C	45	45	45
- Flue gas temperature at min. nominal heat output and 50/30 °C	°C	31	31	31
- Maximum permitted temperature of the combustion air	°C	50	50	50
- Flow rate combustion air	Nm ³ /h	17	23	31
- Maximum supply pressure for supply air and flue gas line	Pa	100	100	100
- Maximum draught/depression at flue gas outlet	Pa	-50	-50	-50

¹⁾ In relation to natural gas G20 (100 % methane). With a hydrogen content (H₂) of up to 20 % in accordance with DVGW ZP3100, an output reduction of up to 7 % is possible.

²⁾ Factory measurements

³⁾ Data related to NCV.

⁴⁾ Data related to NCV. The boiler series is tested for EE/H setting. With a factory setting to a Wobbe value of 15.0 kWh/m³, operation in the Wobbe value range from 12.0 to 15.7 kWh/m³ is possible (readjustment might be necessary).

⁵⁾ Flow resistance boiler in mbar = flow rate (m³/h)² x z; resp. see diagrams

⁶⁾ Compare notice at "Engineering".

Hoval UltraGas® (35-100)

Type		(35)	(50)	(70)	(100)
• Nominal heat output at 80/60 °C, natural gas ¹⁾	kW	5.2-33.0	7.5-46.0	12.1-64.5	19.0-92.0
• Nominal heat output at 50/30 °C, natural gas ^{1), 2)}	kW	5.8-34.3	8.0-48.8	13.5-69.0	20.9-99.0
• Nominal heat output at 80/60 °C, propane ³⁾	kW	6.9-32.2	9.9-45.5	15.4-63.3	23.0-92.0
• Nominal heat output at 50/30 °C, propane ²⁾	kW	7.6-34.3	10.9-49.9	17.1-69.0	25.0-99.0
• Nominal heat input with natural gas ⁴⁾	kW	5.4-33.3	7.7-46.9	12.5-65.5	19.6-94.1
• Nominal heat input with propane ³⁾	kW	7.2-33.4	10.2-47.2	16.0-65.5	23.8-94.1
• Operating pressure heating min./max. (PMS)	bar	1/3	1/3	1/4	1/4
• Operating temperature max. (T _{max})	°C	85	85	85	85
• Boiler water content (V _(H₂O))	l	81	75	157	144
• Flow resistance boiler ⁵⁾	z value	1.1	1.1	1.5	1.5
• Minimum circulation water quantity	l/h	-	-	-	-
• Boiler weight (without water content, incl. cladding)	kg	205	217	302	331
• Boiler efficiency at 80/60 °C in full-load operation (NCV/GCV)	%	97.9/88.2	98.0/88.3	98.0/88.3	97.6/87.9
• Boiler efficiency at 30 % partial load operation (NCV/GCV)	%	108.1/97.4	108.1/97.4	108.1/97.4	108.1/97.4
• Room heating energy efficiency					
- without control	ηs	92	92	92	92
- with control	ηs	94	94	94	94
- with control and room sensor	ηs	96	96	96	96
• NOx class (EN 15502)		-	-	-	-
• Nitrogen oxide emissions (EN 15502) (GCV) NOx	mg/kWh	26	28	28	29
• CO ₂ -content in flue gas at min./max. nominal heat output	%	8.8/9.0	8.8/9.0	8.8/9.0	8.8/9.0
• Heat loss in standby mode	Watt	220	220	290	290
Dimensions		see table of dimensions			
• Gas flow pressure min./max.					
- Natural gas E/LL	mbar	17.4-50	17.4-50	17.4-50	17.4-50
- Propane	mbar	37-50	37-50	37-50	37-50
• Gas connection values at 15 °C/1013 mbar:					
- Natural gas E (Wo = 15.0 kWh/m ³) NCV = 9.97 kWh/m ³	m ³ /h	0.54-3.34	0.77-4.70	1.25-6.57	1.97-9.44
- Natural gas LL- (Wo = 12.4 kWh/m ³) NCV = 8.57 kWh/m ³	m ³ /h	0.63-3.89	0.90-5.47	1.46-7.64	2.29-10.98
- Propane (NCV = 25.9 kWh/m ³)	m ³ /h	0.28-1.29	0.39-1.82	0.62-2.53	0.92-3.63
• Operating voltage	V/Hz	230/50	230/50	230/50	230/50
• Electrical power consumption min./max.	Watt	24/95	26/119	25/91	21/230
• Stand-by	Watt	9	9	9	9
• Type of protection	IP	20	20	20	20
• Permitted ambient temperature during operation	°C	5-40	5-40	5-40	5-40
• Sound power level					
- Heating noise (EN 15036 Part 1) (room air dependent)	dB(A)	62	60	64	67
- Flue gas noise radiated from the mouth (DIN 45635 Part 47) (room air dependent/independent of room air)	dB(A)	55	58	55	59
- Sound pressure level heating noise (depending on installation conditions) ⁶⁾	dB(A)	55	53	57	59
• Condensate quantity (natural gas) at 40/30 °C	l/h	3.1	4.4	6.2	8.9
• pH value of the condensate	approx.	4.2	4.2	4.2	4.2
• Construction type		B23, B23P, C53, C63			
• Flue gas system					
- Temperature class		T120	T120	T120	T120
- Flue gas mass flow at max. nominal heat input (dry)	kg/h	55	78	109	157
- Flue gas mass flow at min. nominal heat input (dry)	kg/h	8.1	11.6	18.8	29.5
- Flue gas temperature at max. nominal heat output and 80/60 °C	°C	65	68	63	65
- Flue gas temperature at max. nominal heat output and 50/30 °C	°C	46	46	43	44
- Flue gas temperature at min. nominal heat output and 50/30 °C	°C	31	31	31	32
- Maximum permitted temperature of the combustion air	°C	50	50	50	50
- Flow rate combustion air	Nm ³ /h	41	58	81	117
- Maximum supply pressure for supply air and flue gas line	Pa	120	120	130	130
- Maximum draught/depression at flue gas outlet	Pa	-50	-50	-50	-50

¹⁾ In relation to natural gas G20 (100 % methane). With a hydrogen content (H₂) of up to 20 % in accordance with DVGW ZP3100, an output reduction of up to 7 % is possible.

²⁾ Factory measurements

³⁾ Data related to NCV.

⁴⁾ Data related to NCV. The boiler series is tested for EE/H setting. With a factory setting to a Wobbe value of 15.0 kWh/m³, operation in the Wobbe value range from 12.0 to 15.7 kWh/m³ is possible (readjustment might be necessary).

⁵⁾ Flow resistance boiler in mbar = flow rate (m³/h)² x z; resp. see diagrams

⁶⁾ Compare notice at "Engineering".

Flow resistance on the heating water side

UltraGas® (15-27)

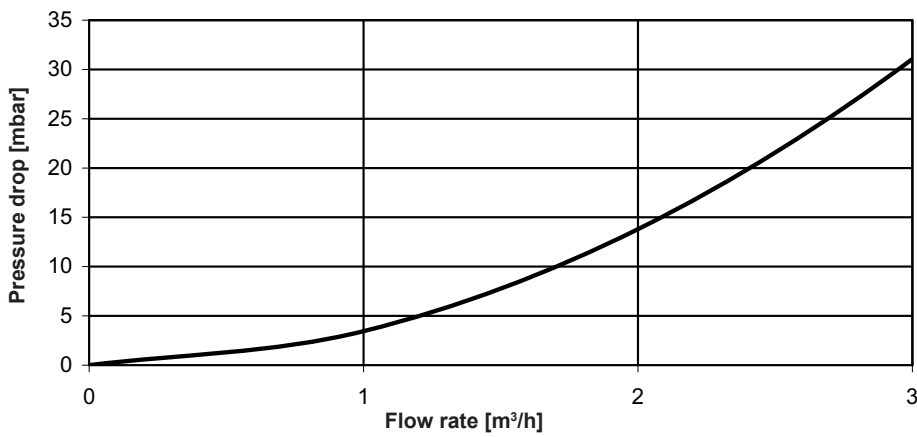

UltraGas® (35,50)

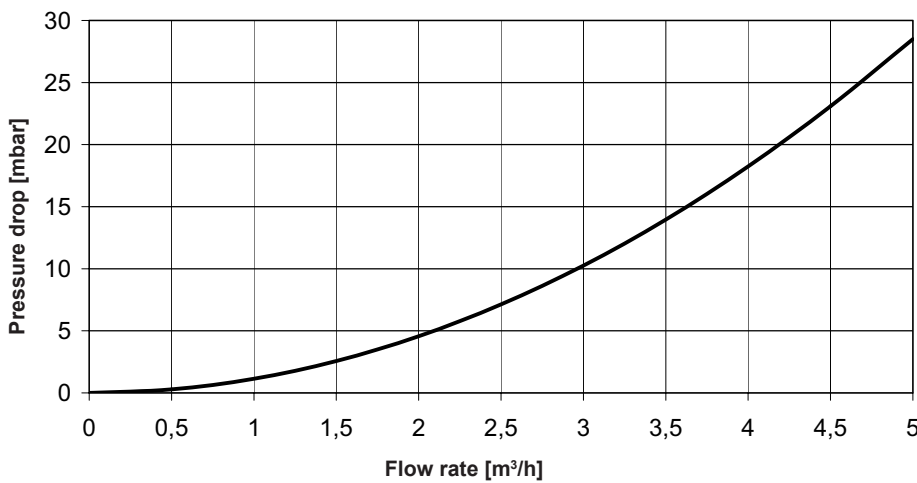

UltraGas® (70,100)

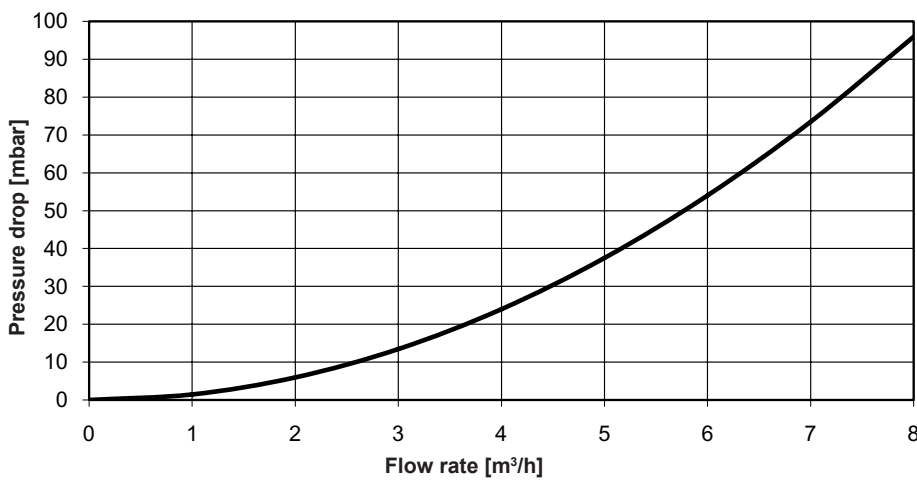

UltraGas® (15-27) with connection set AS25-S/NT/HT and armature group HA25
 UltraGas® (35,50) with connection set AS32-S/NT/HT and armature group HA32

(Dimensions in mm)

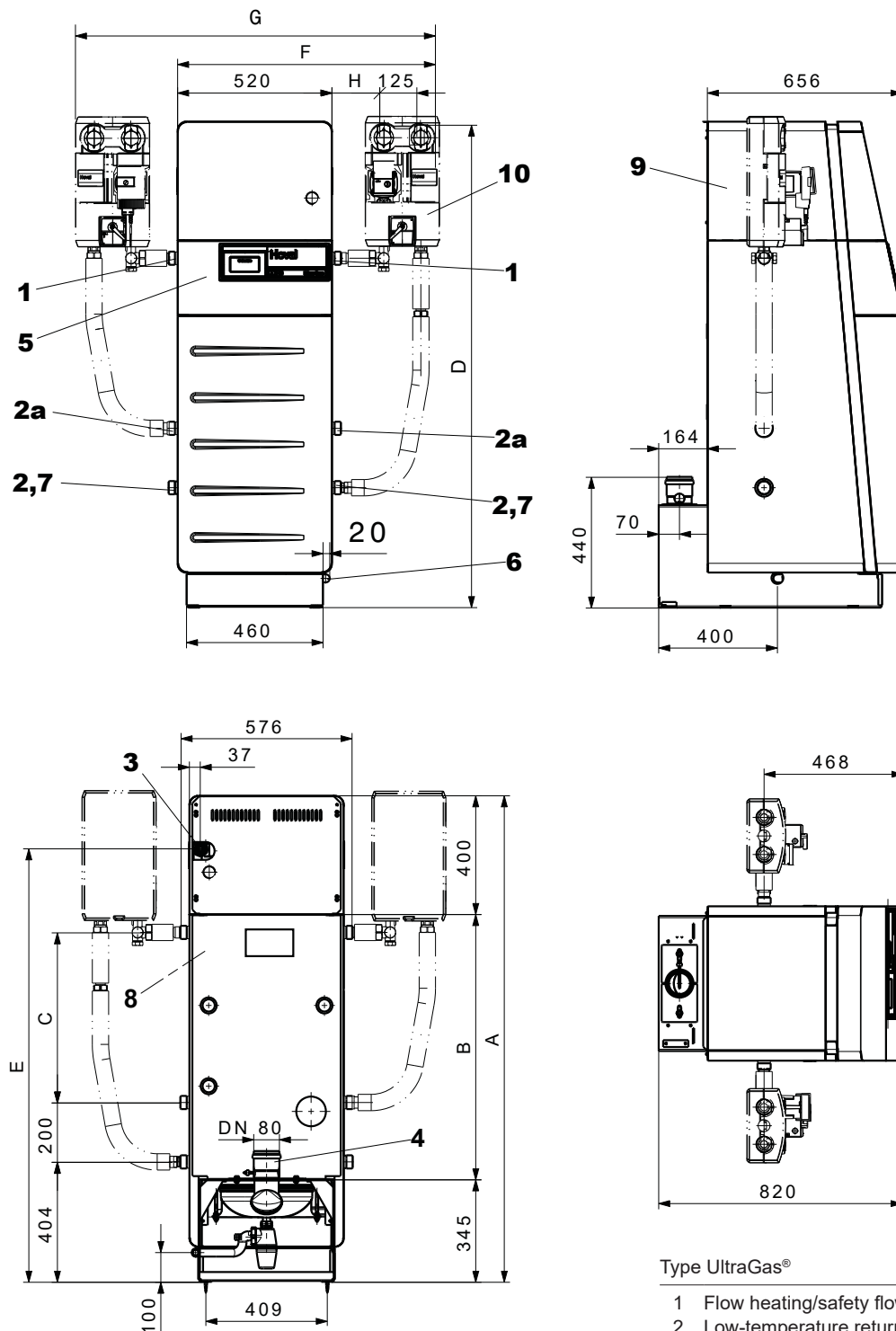

Type UltraGas® (15-27) (35,50)

Type UltraGas®	(15-27)	(35,50)
1 Flow heating/safety flow	R 1"	R 1 1/4"
2 Low-temperature return	R 1"	R 1 1/4"
2a High-temperature return	R 1"	R 1 1/4"
3 Gas connection	Rp 3/4"	Rp 3/4"
4 Flue gas outlet	DN 80	DN 80
5 Control panel		
6 Condensate drain (left or right) incl. siphon (DN 25) and 2 m PVC passage tube inner Ø 19 x 4 mm		
7 Drain		
8 Electric cable entry point		
9 Sound attenuation cowl		
10 Heating armature group or charging group (option)		

Type	A	B	C	D	E	F	G	H
UltraGas® (15-27)	1400	655	333	1330	1220	852	1184	144
UltraGas® (35,50)	1640	895	573	1620	1460	930	1340	222

Hoval UltraGas® (70,100) with connection set AS40-S/NT/HT and armature group HA40
(Dimensions in mm)

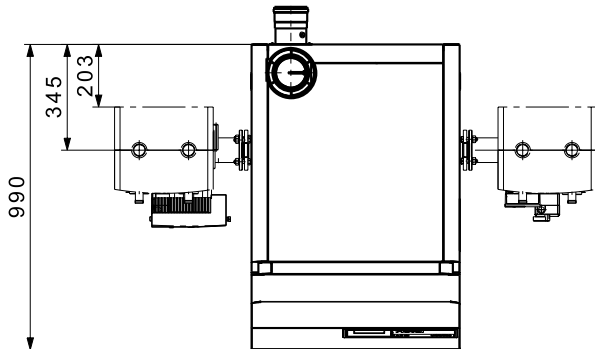
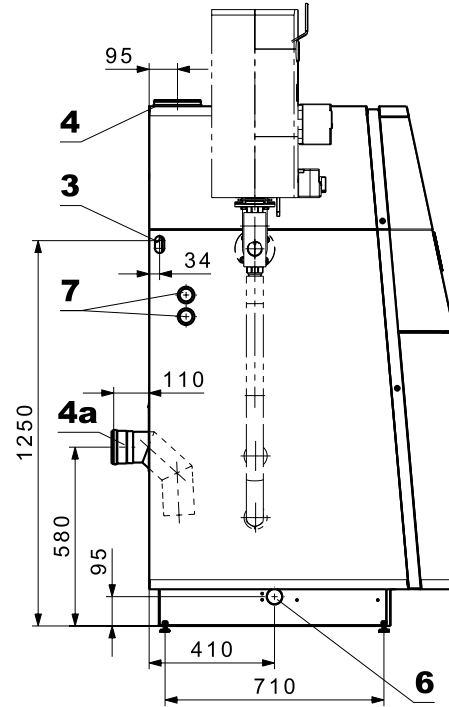
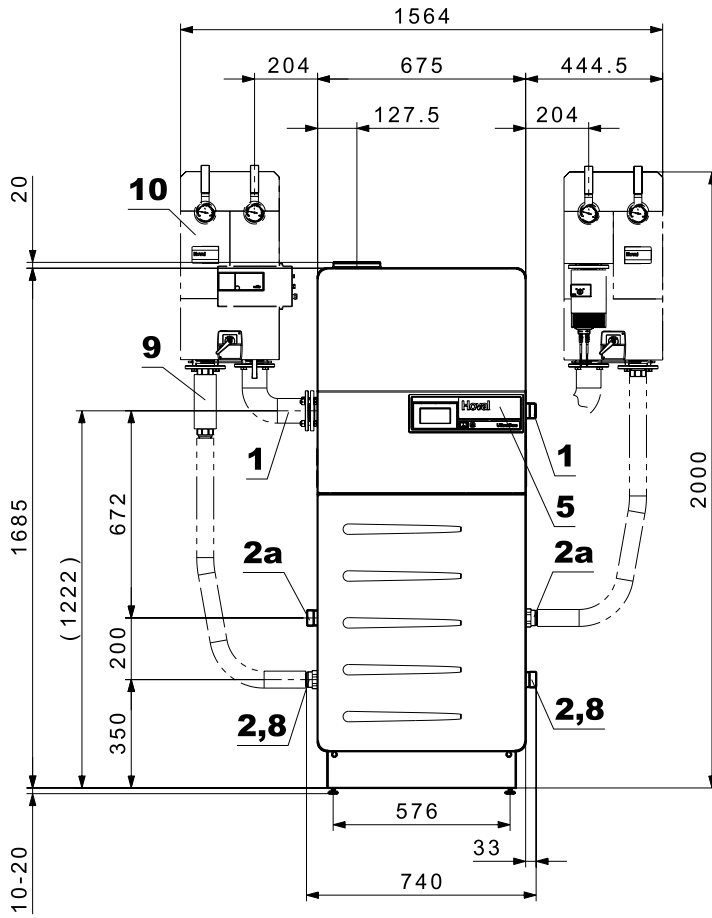

Type UltraGas®	(70)	(100)
1. Flow heating/safety flow	R 1½"	R 1½"
2. Low-temperature return	R 1½"	R 1½"
2a. High-temperature return	R 1½"	R 1½"
3. Duct for the gas pipe left or right	R ¾"	R ¾"
4. Concentrical supply air/flue gas connection	C100/150	C100/150
4a. Combustion air connection to the back (option)	E 100	E 100
5. Control panel		
6. Condensate drain (left or right) incl. siphon (DN 25) and 2 m PVC passage tube inner Ø 19 x 4 mm		
7. Electrical connection left or right		
8. Drain		
9. Connection set (option)		
10. Heating armature group or charging group (option)		

Space requirement
(Dimensions in mm)

UltraGas® (15-50)

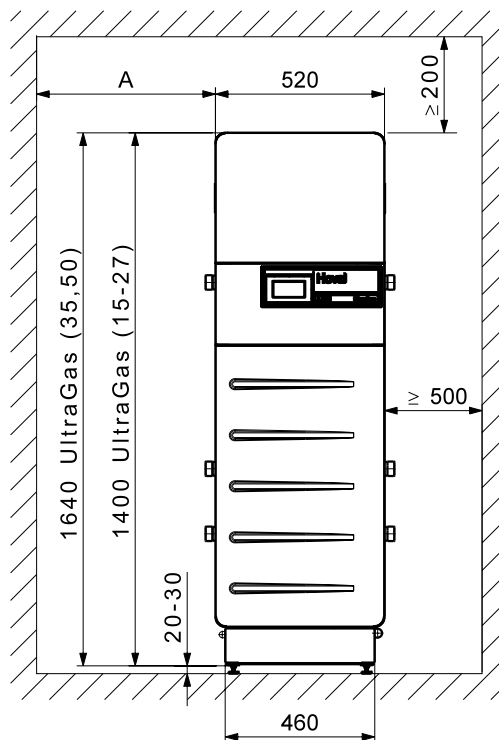
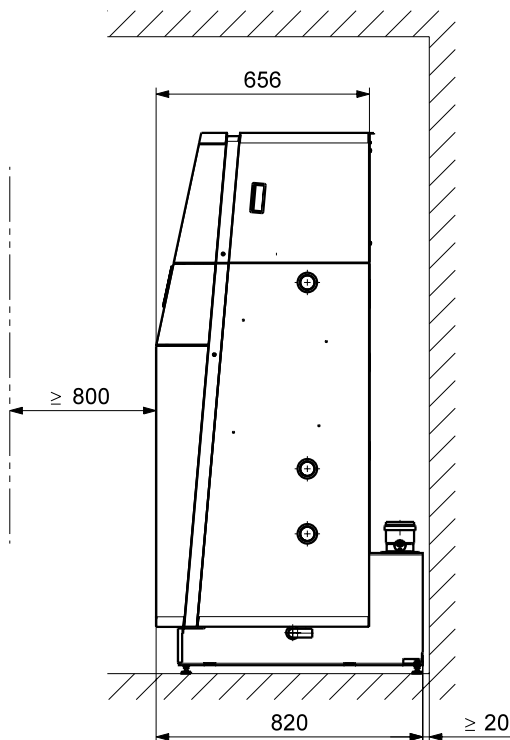

Door of the boiler inclusive burner swivelling to the top and to the left or to the front.

A = minimal 150 mm *

Burner service position in the front - boiler cleaning from the right

A = optimal 300 mm *

Burner service position left - boiler cleaning from the front

Boiler can be placed with the right side directly against the wall however, a minimum gap of 160 mm is required.

* without armature group,

500 mm with armature group

- The cleaning opening must be well accessible.

- Boiler rear side must be accessible.

UltraGas® (70,100)

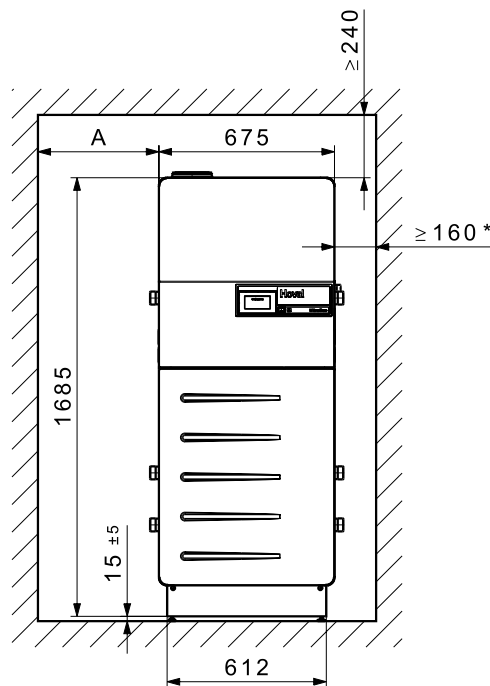
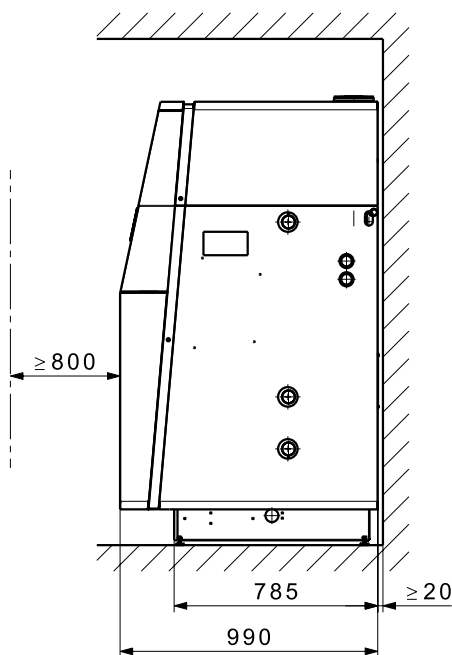

Door of the boiler inclusive burner swivelling to the top and to the left or to the front.

A = minimal 150 mm *

Burner service position in the front - boiler cleaning from the right

A = optimal 300 mm *

Burner service position left - boiler cleaning from the front

* without armature group,

500 mm with armature group

Standards and guidelines

The official regulations for installation and operation must be observed. In particular, these are the country-specific standards (e.g. EN standard, DIN standards, ...) as well as the corresponding regional regulations.

The following standards and guidelines must be complied with:

- Hoval technical information and installation instructions
- hydraulic and technical control regulations of Hoval
- DVGW directives
- DIN EN 12828 Safety-relevant requirements
- DIN EN 12831 Heaters Rules for the calculation of the heat requirements of buildings
- VDI 2035 Protection against damage by corrosion and boiler scale formation in heating and service water installations
- EN 14868 "Protection of metallic materials against corrosion"
- VDE 0100 supplement 2

Water quality in heating systems Filling and replacement water, heating water

The following applies:

- VDI 2035
- In addition, the EN 14868 standard must be applied, **as well as the manufacturer-specific specifications**

Manufacturer-specific specifications

Filling and replacement water

The filling and replacement water can be both fully demineralised and also merely softened.

Heating water

- In the case of **full demineralisation of the filling and replacement water**, the electrical conductivity of the heating water must not exceed the value of 100 µS/cm.
- In the case of **softening the filling and replacement water**, the following conditions must be complied with:
 - Electrical conductivity of the heating water for operation with water containing salts: > 100 µS/cm to ≤ 1500 µS/cm
 - pH value of the heating water for systems without aluminium alloy as water-side material 8.2 to 10.0 (measurement 10 weeks after commissioning at the earliest)

- The sum of the chloride, nitrate and sulphate contents in the heating water must not exceed 50 mg/l in total.

Additional notices

- Hoval boilers and calorifiers are suitable for heating systems without significant oxygen intake. (System type I according to EN 14868).
- Plants with continual oxygen intake (e.g. underfloor heating without diffusion-proof plastic piping) or intermittent oxygen intake (e.g. requiring frequent topping-up) must be equipped with a system separation.
- In the case of bivalent heating systems, the values of the heat generator with the strictest requirement for water quality must be complied with.
- If only the boiler is replaced in an existing plant, it is not recommended for the entire heating system to be refilled, provided that the heating water already contained in the system complies with the relevant directives or standards.
- Before filling new systems and, where necessary, existing heating systems containing heating water that does not comply with the directives or standards, the heating system must be professionally cleaned and flushed. The boiler must not be filled until the heating system has been flushed.

Frost protection agent

- see separate engineering sheet "Use of frost protection agent".

Heating room

- Boilers cannot be positioned in rooms in which halogen compounds can occur and into which combustion air can enter (e.g. wash-, dryer-, work room, hairdressers and so on).
- Halogen compounds can be caused by cleaning and degreasing solutions, disinfectants, glue and bleaching lyes.

Combustion air supply

The supply of combustion air must be guaranteed. There must be no possibility to close the air supply opening. The connection for direct combustion air supply must be used for direct combustion air supply to the boiler (LAS system). It is very important to ensure that the combustion air is free from halogen compounds. These are present, for example, in spray cans, varnishes, glues, solvents and cleansing agents.

The minimum free cross-section for the combustion air can be assumed simplified as follows:

- **Room air-independent operation with separate combustion air pipe to the boiler:** 0.8 cm² per 1 kW of output. The pressure drop in the combustion air pipe must be considered for the calculation of the flue gas system.
- In the UltraGas®, ventilation of the installation or boiler room must be guaranteed for operation independent from the room air.
- **Room air-dependent operation:** Minimum free cross-section of the opening into the open: 150 cm² or twice 75 cm² and additionally 2 cm² necessary for each kW of output over 50 kW for vent into the open.

Gas connection

Commissioning

- Initial commissioning must be performed by a specialist technician from Hoval or a gas specialist technician.
- Burner setting values according to the installation instructions.

Manual gas shut-off valve and gas filter

Immediately in front of the boiler a manual gas shut-off device (valve) must be installed according to relevant regulations. Should the local regulations or conditions demand this, an approved gas filter must be installed in the gas supply pipe between the gas tap (thermally releasing) and the boiler in order to prevent malfunction due to foreign particles being carried along with the gas.

Construction of a recommended gas connection

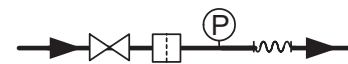

Legend:

 manual gas shut-off valve

 gas hose/compensator

 gas filter

 pressure gauge with test burner and push-button valve

Type of gas

- The boiler is only to be operated with the type of gas stated on the rating plate.

Gas pressure natural gas

- Necessary flow pressure at the boiler inlet: UltraGas® (15-100) min. 17.4 mbar, max. 50 mbar

Gas pressure propane

- A gas pressure controller to reduce the boiler inlet pressure must be installed on-site for propane.
- Necessary gas flow pressure at the boiler inlet: UltraGas® (15-100) min. 37 mbar, max. 50 mbar

Gas pressure regulator

- The installation of a gas pressure regulator is only necessary if the gas flow pressure in the gas network exceeds the maximum permissible gas flow pressure of the UltraGas® or if there are considerable fluctuations in the gas flow pressure.
- Pressure fluctuations in the gas network must be prevented by suitable measures (e.g. gas storage tanks or pressure regulators). The local conditions must be checked in each individual case.

Closed heating system

The boiler is only approved for use in closed heating systems.

Minimum circulation water quantity

No minimum water circulation volume is required.

Calorifier connection

If a calorifier is connected, all heating groups must be provided with a mixer.

Boiler base

The boiler should be placed on a sufficiently high base (boiler base see accessories) to protect it against floor humidity and for the siphon for condensate drain.

Allocation of gas filters for UltraGas® (15-100)

UltraGas® type	Gas throughput natural gas E m³/h	Gas filter type	Dimension	Pressure drop gas filter (with clean filter) mbar
(15)	1.5	70612/6B	Rp ¾"	0.10
(20)	1.9	70612/6B	Rp ¾"	0.10
(27)	2.6	70612/6B	Rp ¾"	0.10
(35)	3.3	70612/6B	Rp ¾"	0.10
(50)	4.7	70612/6B	Rp ¾"	0.13
(70)	6.6	70602/6B	Rp 1"	0.10
(100)	9.5	70602/6B	Rp 1"	0.14

It is essential to set the dimensions of the gas line!

Installation instructions

Please observe the installation instructions supplied with every boiler.

Space requirements

See "Dimensions"

Heating boiler in the attic

- If the gas boiler is positioned on the top floor, the installation of a low water protection, which automatically turns the gas burner off in case of water shortage, is recommended.

Condensate drain

- A permit for discharge of the flue gas condensate into the sewage system must be obtained from the relevant authority or sewer operator.
- The condensate from the flue gas line can be discharged via the boiler. A condensate trap is no longer needed in the flue gas system.
- The condensate must be conducted openly (funnel) into the sewage system.
- Suitable materials for condensate drain:
 - stoneware pipes
 - pipes made from glass
 - pipes made from stainless steel
 - pipes made from plastic: PVC, PE, PP, ABS and UP
- A siphon must be installed at the condensate outlet on the gas boiler (included in the boiler scope of delivery).

Diaphragm pressure expansion tank

- An adequately dimensioned diaphragm pressure expansion tank must be provided.
- The diaphragm pressure expansion tank has to be installed in principle at the boiler return.
- Starting from 70 °C an intermediate tank is necessary.

Safety valve

- At the heating flow a safety valve must be installed. An automatic exhauster is built in the boiler.

Noise damping

The following measures are possible for sound insulation:

- Make boiler room walls, ceiling and floor as solid as possible.
- If there are living areas above or below the boiler room, connect pipes flexibly using expansion joints.
- Connect circulating pumps to the piping network using expansion joints

Noise level

- The acoustic **power** level value is independent on the local and spacial circumstances.
- The acoustic **pressure** level is dependent on the installation conditions and can for instance be 5 to 10 dB(A) lower than the acoustic **power** level at a distance of 1 m.

Recommendation:

If the air inlet at the facade is near a noise sensitive place (window of bedroom, terrace etc.), we recommend to use a sound absorber at the direct combustion air inlet.

Flue gas system

- Gas boilers must be connected to a certified and approved flue gas system such as flue gas lines.
- Flue gas lines must be gas-, condensate- and over pressure-tight.
- The flue gas lines must be secured against unwanted loosening of the plug connections.
- The flue gas system must be connected with an angle, so that the resulting condensate of the flue gas system can flow back to the boiler and can be neutralised there before discharging into the canalisation.
- Gas boilers with condensation heat utilisation are to be connected to a flue gas line min. temperature class T120.
- A flue gas temperature limiter is integrated into the boiler.

Looking for the appropriate hydraulic schematic?
Please contact your local Hoval partner.